

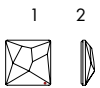









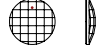









# FLAT BACKS NO HOTFIX

## SUMMARY

	<b>2000</b> SS 3, 4		<b>2420</b> 10, 25 mm		<b>2720</b> 7.5, 9, 12.5 mm
	<b>2006</b> 10, 12, 14, 16 mm		<b>2483</b> 10, 25 mm		<b>2738</b> 10x5, 12x6 mm
	<b>2034</b> SS 10, 20, 48		<b>2493</b> 8, 10, 12, 20, 30 mm		<b>2739</b> 5.8x5.3, 7x6.5 mm
	<b>2035</b> 6, 10, 14, 20, 30, 40 mm		<b>2494</b> 6, 8, 10.5 mm		<b>2740</b> 8.3x8.3, 10x10 mm
	<b>2037</b> 8, 14, 17 mm		<b>2520</b> 8x6, 10x8, 14x10 mm		<b>2753</b> 10, 14 mm
	<b>2058</b> SS 5, 6, 7, 8, 9, 10		<b>2540</b> 7x5.5, 9x7, 12x9.5 mm		<b>2753/G</b> 10, 14 mm
	<b>2072</b> 8, 10, 12 mm		<b>2555</b> 8x2.6, 12x4, 15x5 mm		<b>2770</b> 6x3.5, 12x7 mm
	<b>2088</b> SS 12, 14, 16, 20, 30, 34, 40, 48		<b>2570</b> 50x16 mm		<b>2788</b> 8, 10 mm
	<b>2088/G</b> SS 20, 34		<b>2585</b> 8, 10, 14 mm		<b>DESIGNER EDITION</b> <b>2797</b> 8x4, 10x5 mm
	<b>2200</b> 8x4 mm		<b>2611</b> 8, 10, 14 mm		<b>2798</b> 8, 10, 14 mm
	<b>2204</b> 6x4.8, 10x8, 14x11 mm		<b>DESIGNER EDITION</b> <b>2612</b> 6, 10, 14 mm		<b>2808</b> 6, 10, 14 mm
	<b>2205</b> 7.5, 10, 14 mm		<b>2708</b> 8x8.7, 12.5x13.6 mm		<b>2813</b> 8x5.5, 10x7, 14x9.5 mm
	<b>2300</b> 8x4.8, 10x6 mm		<b>2709</b> 10x6, 13x8 mm		<b>2816</b> 5 mm
	<b>2304</b> 6x1.7, 10x2.8, 14x3.9 mm		<b>2714</b> 6, 10, 14 mm		<b>2826</b> 5 mm
	<b>2400</b> 3, 4, 6 mm		<b>2716</b> 5 mm		<b>2854</b> 8, 12 mm
					<b>2858</b> 6x4.5, 9x6.5, 12x8.5 mm

1 Top view 2 Side view  
 • The logo position is marked by a red dot.

OCEAN MYSTERIES DESIGNED  
BY CÉLINE COUSTEAU

**Design Story:** A love for the sea runs through her veins: Céline Cousteau is a celebrated filmmaker, humanitarian, and environmentalist, and, as it so happens, the granddaughter of legendary ocean explorer Jacques Yves Cousteau. She presents her first ever crystal designs for Swarovski, inspired by one of her favorite places, the depths of the ocean. Taking inspiration from nature itself

and leaving its beauty unaltered, her stunningly life-like creatures are not only captivating and spellbinding, they also draw attention toward the mysterious, mostly unseen, and unexplored world beneath the ocean's surface on which all ocean life depends. These mysteries need to be protected for future generations, both above and below the water.

07 FLAT BACKS NO HOTFIX

2612 Jelly Fish Flat Back partly frosted No Hotfix

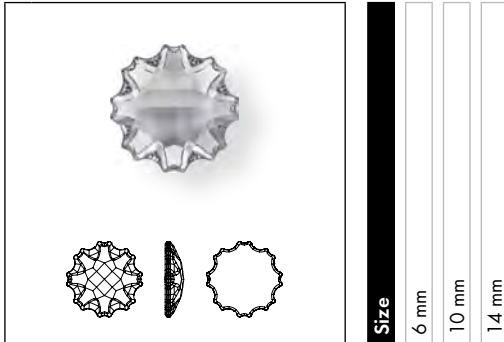

Size	6 mm	10 mm	14 mm
------	------	-------	-------

Crystal	6 mm	10 mm	14 mm
Crystal F (001)	■	■	■
Colors			
Plain Colors			
Blush Rose F (257)	■	■	■
Jet (280)	■	■	■
Tanzanite F (539)	■	■	■
Opal Colors			
White Opal F (234)	■	■	■
Crystal Effects			
Transparent Effects			
Crystal AB F (001 AB)	■	■	■
Crystal Bermuda Blue F (001 BBL)	■	■	■
Crystal Blue Shade F (001 BLSH)	■	■	■
Crystal Golden Shadow F (001 GSHA)	■	■	■
Crystal Luminous Green F (001 LUMG)	■	■	■
Crystal Silver Night (001 SINI)	■	■	■

# FLAT BACKS NO HOTFIX

07 FLAT BACKS NO HOTFIX

## 2738 Triangle Alpha Flat Back

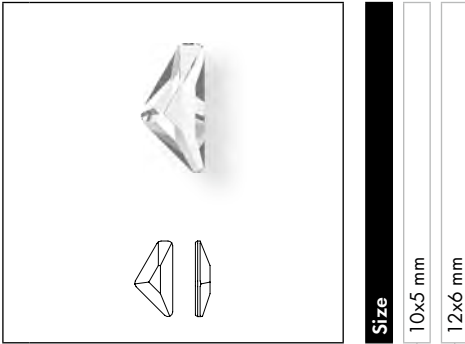

Size

10x5 mm

12x6 mm

### Crystal

Crystal F (001)

### Colors

#### Plain Colors

Blush Rose F (257)

Jet (280)

Light Colorado Topaz F (246)

Light Sapphire F (211)

Light Siam F (227)

### Crystal Effects

#### Transparent Effects

Crystal AB F (001 AB)

Crystal Golden Shadow F (001 GSHA)

Crystal Silver Night (001 SINI)

### Crystal Lacquer<sup>PRO</sup>

Crystal Dark Grey (001 L111S)

Crystal Dark Red (001 L108S)

Crystal Ivory Cream (001 L106S)

## 2739 Triangle Beta Flat Back

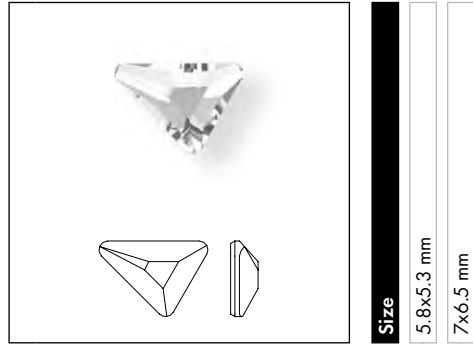

Size

5.8x5.3 mm

7x6.5 mm

### Crystal

Crystal F (001)

### Colors

#### Plain Colors

Blush Rose F (257)

Jet (280)

Light Colorado Topaz F (246)

Light Sapphire F (211)

Light Siam F (227)

### Crystal Effects

#### Transparent Effects

Crystal AB F (001 AB)

Crystal Golden Shadow F (001 GSHA)

Crystal Silver Night (001 SINI)

### Crystal Lacquer<sup>PRO</sup>

Crystal Dark Grey (001 L111S)

Crystal Dark Red (001 L108S)

Crystal Ivory Cream (001 L106S)

# FLAT BACKS NO HOTFIX

## 2740 Triangle Gamma Flat Back

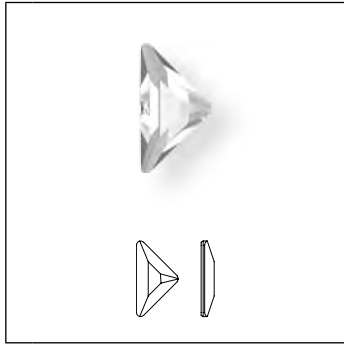

**Size**

8.3x8.3 mm

10x10 mm

### Crystal

Crystal F (001)

### Colors

#### Plain Colors

Blush Rose F (257)

Jet (280)

Light Colorado Topaz F (246)

Light Sapphire F (211)

Light Siam F (227)

### Crystal Effects

#### Transparent Effects

Crystal AB F (001 AB)

Crystal Golden Shadow F (001 GSHA)

Crystal Silver Night (001 SINI)

### Crystal Lacquer<sup>PRO</sup>

Crystal Dark Grey (001 L111S)

Crystal Dark Red (001 L108S)

Crystal Ivory Cream (001 L106S)

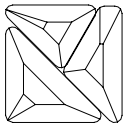

Alpha, Beta & Gamma FBs  
create together a square.

# FLAT BACKS NO HOTFIX

07 FLAT BACKS NO HOTFIX

## 2753 Edelweiss Flat Back

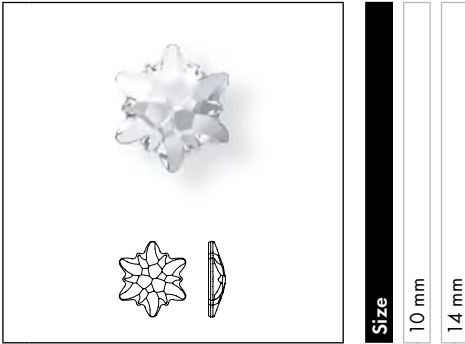

**Size**  
10 mm  
14 mm

- Crystal**
- Crystal F (001)
- Colors**
- Plain Colors**
- Amethyst F (204)
- Denim Blue F (266)
- Light Siam F (227)
- Vintage Rose F (319)
- Opal Colors**
- White Opal F (234)
- Crystal Effects**
- Transparent Effects**
- Crystal AB F (001 AB)
- Crystal Blue Shade F (001 BLSH)
- Crystal Golden Shadow F (001 GSHA)
- Crystal Luminous Green F (001 LUMG)
- Crystal Silver Night (001 SINI)
- Metallic Effects**
- Crystal Metallic Sunshine F (001 METSH)

## 2753/G Edelweiss Flat Back partly frosted



**Size**  
10 mm  
14 mm

- Crystal**
- Crystal F (001)
- Crystal Effects**
- Transparent Effects**
- Crystal AB F (001 AB)
- Crystal Blue Shade F (001 BLSH)
- Crystal Golden Shadow F (001 GSHA)
- Crystal Luminous Green F (001 LUMG)
- Crystal Silver Night (001 SINI)
- Metallic Effects**
- Crystal Metallic Sunshine F (001 METSH)

## 2788 Wave Flat Back



**Size**  
8 mm  
10 mm

- Crystal**
- Crystal F (001)

# FLAT BACKS NO HOTFIX

## 2798 Contour Flat Back

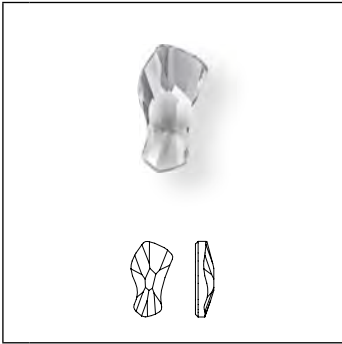

Size	8 mm	10 mm	14 mm
------	------	-------	-------

### Crystal

Crystal F (001)

### Colors

#### Plain Colors

Graphite F (253)

Jet (280)

Light Colorado Topaz F (246)

Light Silk F (261)

#### Opal Colors

Light Grey Opal F (383)

White Opal F (234)

### Crystal Effects

#### Transparent Effects

Crystal AB F (001 AB)

Crystal Blue Shade F (001 BLSH)

Crystal Golden Shadow F (001 GSHA)

Crystal Silver Night (001 SINI)

#### Metallic Effects

Crystal Iridescent Green F (001 IRIG)

07 FLAT BACKS NO HOTFIX

# FLAT BACKS NO HOTFIX

## 2854 Butterfly Flat Back

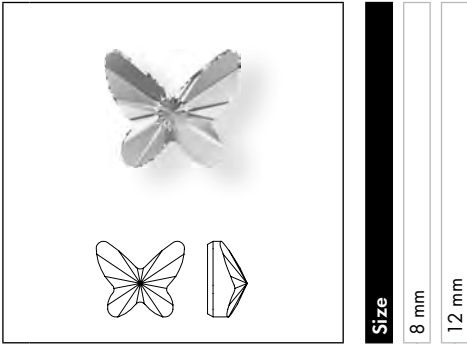

Crystal	
Crystal F (001)	■ ■
Colors	
Plain Colors	
Amethyst F (204)	■ ■
Denim Blue F (266)	■ ■
Light Rose F (223)	■ ■
Crystal Effects	
Transparent Effects	
Crystal AB F (001 AB)	■ ■
Crystal Antique Pink F (001 ANTP)	■ ■
Crystal Golden Shadow F (001 GSHA)	■ ■
Crystal Silver Night F (001 SINI)	■ ■

07 FLAT BACKS NO HOTFIX